

**DEVELOPMENT OF A COMPUTER CONTROLLED
UNDERBODY FLOW**

IOWA HIGHWAY RESEARCH BOARD PROJECT TR 412

FINAL REPORT

Wilfrid A Nixon, George Kochumman, Carrie Novotny, and Anton Kruger



IIHR Technical Report No. 448

IIHR—Hydroscience & Engineering
College of Engineering
The University of Iowa
Iowa City IA 52242

January 2006

ACKNOWLEDGEMENTS

This project was made possible by funding from the Iowa Highway Research Board, Project Number TR 412. This support is gratefully acknowledged, as is the assistance of Mr. Mark Dunn in bringing this project to completion.

The support of the Directors of IIHR Hydrosience and Engineering during the execution of this project, Dr. V.C. Patel and Dr. L.J. Weber, enabled this study to proceed. The computer support staff at IIHR, led by Mr. Mark Wilson and assisted by Mr. Brian Miller, made the development of the computer model possible. Their assistance with program installation and troubleshooting was particularly invaluable. The drafting work of Mr. Mike Kundert was very helpful.

The opinions, findings, and conclusions expressed in this publication are those of the authors, and not necessarily those of the Iowa Highway Research Board.

ABSTRACT

Underbody plows can be very useful tools in winter maintenance, especially when compacted snow or hard ice must be removed from the roadway. By the application of significant down-force, and the use of an appropriate cutting edge angle, compacted snow and ice can be removed very effectively by such plows, with much greater efficiency than any other tool under those circumstances.

However, the successful operation of an underbody plow requires considerable skill. If too little down pressure is applied to the plow, then it will not cut the ice or compacted snow. However, if too much force is applied, then either the cutting edge may gouge the road surface, causing significant damage often to both the road surface and the plow, or the plow may ride up on the cutting edge so that it is no longer controllable by the operator. Spinning of the truck in such situations is easily accomplished. Further, excessive down force will result in rapid wear of the cutting edge.

Given this need for a high level of operator skill, the operation of an underbody plow is a candidate for automation. In order to successfully automate the operation of an underbody plow, a control system must be developed that follows a set of rules that represent appropriate operation of such a plow. These rules have been developed, based upon earlier work in which operational underbody plows were instrumented to determine the loading upon them (both vertical and horizontal) and the angle at which the blade was operating.

These rules have been successfully coded into two different computer programs, both using the MatLab® software. In the first program, various load and angle inputs are analyzed to determine when, whether, and how they violate the rules of operation. This program is essentially deterministic in nature. In the second program, the Simulink® package in the MatLab® software system was used to implement these rules using fuzzy logic. Fuzzy logic essentially replaces a fixed and constant rule with one that varies in such a way as to improve operational control. The development of the fuzzy logic in this simulation was achieved simply by using appropriate routines in the computer software, rather than being developed directly.

The results of the computer testing and simulation indicate that a fully automated, computer controlled underbody plow is indeed possible. The issue of whether the next

steps toward full automation should be taken (and by whom) has also been considered, and the possibility of some sort of joint venture between a Department of Transportation and a vendor has been suggested.

TABLE OF CONTENTS

	<u>Page</u>
ACKNOWLEDGEMENTS.....	i
ABSTRACT	ii
1. INTRODUCTION	1
2. SYSTEM CONCEPT.....	3
2.1 Electronic Control of Hydraulics	3
2.2 Computer Coding of the Expert System	4
2.3 System Integration	6
3. PARAMETERS FOR CODING.....	8
3.1 Input Management Section	9
3.2 Rule Checking Modules.....	14
3.3 Output Module	16
4. CODE DEVELOPMENT	20
4.1 MatLab Program Development.....	20
4.2 Simulink© Program Development	22
4.2.1 Control system process	23
4.2.2 Simulink.....	23
5. RESULTS	28
5.1 MatLab Program Results	28
5.2 Simulink Program Results	31
5.3 Implications of Results on the Deployment Decision.....	34
6. CONCLUSIONS.....	35
7. REFERENCES	36
APPENDIX A	37

LIST OF FIGURES

<u>Figure</u>		<u>Page</u>
2.1	Schematic of the Hydraulic System.....	4
2.2	Concept of Fuzzy Relationships versus Deterministic Relationships.....	5
3.1	Typical Horizontal and Vertical Force Data for an Underbody Plow	10
3.2	Typical Blade Angle and Force Angle Data for an Underbody Plow	11
3.3	Vertical Force Data Set A to Test Rules 2 and 4.....	13
3.4	Vertical Force Data Set B to Test Rule 5.....	14
3.5	Blade Angle Data Set C to Test Rules 6 and 7	15
3.6	Blade Angle Data Set D to Test Rules 6 and 7	16
3.7	Force Angle Data Set E to Test Rule 8.....	17
3.8	Horizontal Force Data Set F to Test Rule 9.....	18
4.1	Smoothing Process.....	21
4.2	The Rule Checking Module	22
4.3	Simulink model.....	24
4.4	Simulink model with force and displacement as variables.....	25
4.5	Parameters of the force function	26
4.6	Parameters of the displacement function	26
5.1	Smoothed input data	30
5.2	The Output Vertical Force in Response to a Force Violation.....	31
5.3	Force function	32
5.4	Displacement function	33

LIST OF TABLES

<u>Table</u>		<u>Page</u>
2.1	Preliminary Listing of Expert System Rules	6
3.1	Conditions to be tested.....	12
3.2	Data Sets used for Condition Testing	13
5.1	Results of tests of data sets that violate operational rules.....	29

1. INTRODUCTION

Underbody plows are used in winter maintenance activities to remove ice and compacted snow from the road surface. Typically, such plows are only used when conditions are very severe, such as during an ice storm or after heavy snow fall, when snow on the roadway has been compacted by vehicle traffic. Underbody plows are typically mounted to tandem axle trucks. Sometimes, motor graders are used for snow removal, and the blade operation in these cases is similar to that for an underbody mounted on a truck.

Effective operation of an underbody plow is not a simple task. If too little down pressure is applied to the underbody plow, then it will not cut the ice or compacted snow. However, if too much force is applied, then one of two bad outcomes may occur. The cutting edge may gouge the road surface, causing significant damage often to both the road surface and the plow. Alternatively, the plow may ride up on the cutting edge so that it is no longer controllable by the operator. Spinning of the truck in such situations is easily accomplished. Further, excessive down force will result in rapid wear of the cutting edge. Anecdotal reports indicate that the whole edge may get worn away in a matter of minutes, which event is rapidly followed by the wearing and eventual destruction of the underbody mold board. In short, effective operation of an underbody plow in winter maintenance is a skilled art.

It is precisely because the operation of an underbody plow requires such skill that such operation is a good candidate for automation. As skilled truck operators retire, it becomes harder to replace them with new labor of equal skills. Training in underbody use thus becomes a harder task, and both plow effectiveness and operator safety may suffer as a result. In cases in which the skill pool is shrinking, the use of so called “expert systems” presents a way in which these skills may be effectively preserved.

The benefits of using an expert system to control an underbody plow during snow and ice removal operations are twofold. First, provided a suitable expert system is developed, the plow will operate at a very high level of effectiveness, since the parameters for its operation will be developed from data taken from plowing conducted by highly experienced and skilled operators. Thus the plow will give good performance

regardless of the skill level of the operator. Second, by allowing the operator to concentrate on driving the truck (essentially by making the plow operation a “hands free” process) plowing safety should also be improved. Thus the use of an expert system to control the underbody should benefit both safety and efficiency in winter maintenance operations.

The purpose of this study is to examine whether the development of a computer controlled underbody plow is feasible. The initial plan was to implement such a system on a plow, and test it in the field, but a revision in funding level limited the investigation to a bench test of the software required for the automation. Thus this study presents the three steps that would be needed to implement such a system (electronic control of hydraulics, computer coding of the expert system, and system integration) in concept, and then details the computer coding and the testing of that coding. The issue of whether the next steps toward full automation should be taken (and by whom) is also considered.

2. SYSTEM CONCEPT

The system to operate an underbody plow automatically and autonomously can be broken into three parts. These parts, the electronic control of hydraulics, the computer coding of the expert system, and system integration, are each considered in more detail below.

2.1 Electronic Control of Hydraulics

In order to control the underbody plow with a computer, a first step is to ensure that the hydraulic system that operates the plow can be electronically controlled. One such system is shown in Figure 2.1. In this system, the plow can be operated both electronically and manually. In a fully deployed system, the manually operated actuators could be removed.

In an electronically controlled system, a first level of implementation replaces manual control (via levers) with electronic control that is still human-initiated. That is, rather than adjust the plow position and force by manually operating levers the operator will be entering commands on a keypad. Such a system could provide a full range of possible plow positions and force levels, but is clearly somewhat less wieldy in that regard than a traditional system. Rather, a significant benefit could be obtained from such a system if the keypad presented the operator with a limited number of pre-set actuator conditions.

The use of pre-sets in this manner would serve as an interim to a full computer controlled deployment. Clearly, if the pre-sets were well chosen, then even an unskilled operator would be able to achieve adequate system performance. However, the drawback of this interim system is that it cannot adapt to changing positions on the road. This lack of flexibility might, under certain conditions, lead to circumstances in which blade or pavement damage was all but assured. The approach proposed herein avoids this potential drawback by using the force levels measured in the plow itself as a feedback signal to control the plow forces. Thus, provided the feedback algorithm is appropriate, the danger of damaging plow or road is mitigated.

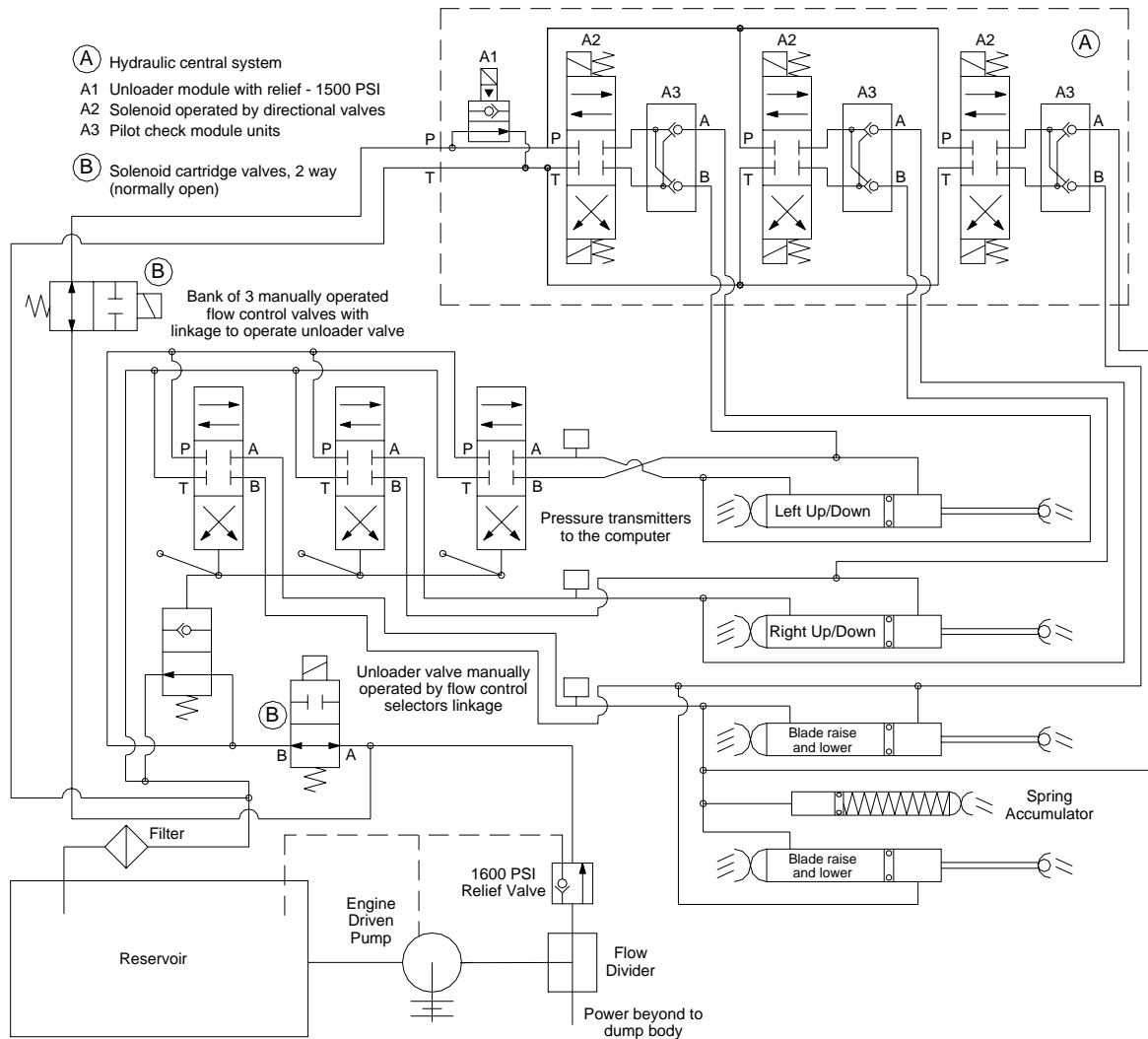

Figure 2.1: Schematic of The Hydraulic System

2.2 Computer Coding of the Expert System

A major component in this system is the development of the controlling expert system. A review of the TRIS database indicates that although expert systems have been discussed a great deal in ITS areas, especially in regard to collision avoidance, they are relatively little used.

An expert system is a computer program based upon a series of “If... then” statements. These statements are termed the rules of the system. Codifying these rules is a major part of the development of an expert system. Fortunately, the tests which have been

conducted both in closed road testing of underbody plows and in field-deployed testing of Iowa Department of Transportation trucks at the Oakdale garage provide an excellent database from which such a rule set can be derived (Nixon and Potter, 1997).

However, such a series of rules would, if implemented strictly, lead to an over-constrained system. Thus, in general, a process is applied to the rules, sometimes termed “fuzzy logic” or “fuzzy engineering.” This area of systems control is considered in greater detail by Kosko (1997). The basis of this approach is to transform a curve into a series of “fuzzy” regions (see Figure 2.2). This fuzziness represents the reality that the “If...then” rules are only imperfectly known. Fuzzy engineering has been used in a number of computer controlled engineering applications.

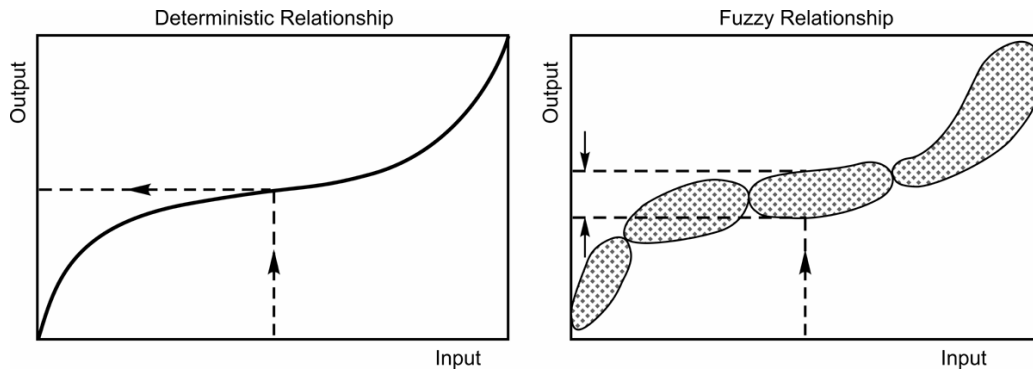

Figure 2.2: Concept of Fuzzy Relationships versus Deterministic Relationships

A critical part of the expert system is the rules that will be used to build the system. In the initial phase of system development the rules can be written as simple linguistic statements, and as noted by Cox (1994) some of the rules may appear contradictory. A preliminary set of rules for the underbody plow system is shown in Table 2.1. These do not all appear in the form of “If...then” statements, although ultimately they must be transformed into such statements for the purpose of computer coding. The “then” part of such statements may be thought of as being the consequences of a rule violation.

Table 2.1 Preliminary Listing of Expert System Rules

<u>Rule Number</u>	<u>Rule Description</u>
Rule 1	When the plow is “on” it should be scraping
Rule 2	The operator should be able to control the truck
Rule 3	If the panic button is pushed, then the plow should disengage quickly and safely
Rule 4	The down force should not be too high
Rule 5	The down force should not be too low
Rule 6	The blade should operate close to the vertical
Rule 7	The blade should be at an angle between 0 and 30 degrees
Rule 8	The ratio of horizontal to vertical force should be high
Rule 9	The horizontal force should be high

The numerical values (in for example, rule 4) will be obtained from Nixon and Potter (1997). The expert system will be tested using a computer driven simulated plow that produces output in response to the controlling system input. The output will be somewhat randomized (or “fuzzed”), yet based on actual data gathered by Nixon and Potter from in-service plowing experiments.

2.3 System Integration

The first two parts of this project (as outlined in sections 2.1 and 2.2 above) will produce a system capable in theory of providing computer control of an underbody plow. However, the final stage of system integration is unlikely to be straightforward. A major issue in this regard is response time of the hydraulic system. The computer control system will provide signals to drive the actuators that are based on immediate or very rapid response to the signals by the system. In reality, there is some lag between the signal and a change in the loading observed by the computer system. If the feedback process is not damped or detuned, the system will be unstable, over-correcting the input signal, because no output response has yet been observed. While some approximations of the extent of de-tuning or damping can be made, the actual parameters will have to be

determined in-situ. This is not a simple process, and while beyond the scope of this project, would clearly need to be considered in any implementation of the system.

A further consideration is the human factors aspect of this project. The goal of the project is to take the control of the underbody plow away from the operator and give it to a computer. This is likely to bring about a certain level of discomfort among operators. The system integration must be conducted in such a way that operators are quite clear that they have the ability to over-ride the system. Further, operators will need to be convinced that the system can operate safely on its own. Again, this topic lies beyond the scope of this study, yet it too is a critical step to be considered in the implementation of the system.

3. PARAMETERS FOR CODING

In developing the code for this project, the goal was to ensure that, insofar as possible, the bench test model was similar to that which would be used in real life. However, a number of inevitable differences existed. In a deployed version of the system, the computing would be handled by some sort of programmable logic controller or PLC. In the bench test, all computing was done on a desktop PC machine. The program code for PLCs varies from system to system, but in the prototype testing, the programming language of MatLab was used, because this includes an extensive library of subroutines that relates to fuzzy logic systems.

In addition to testing with the standard version of MatLab, a simulation program termed Simulink © (which is an extension of the algorithm development capabilities of MatLab) was also used to test some of the feedback aspects of this project. This approach is described more completely in Chapter 4.

Another obvious difference between the bench test and the full scale deployment was that the input and output data would come from and be written to data files in the bench test, whereas in the full scale, these would come directly from and go to the electronic interface with the hydraulic system. The input data set was developed from data recorded in previous field studies of underbody plow performance (Nixon and Potter, 1997) and comprised vertical force, horizontal force, and plow blade angle. These three parameters would be the ones used to control the fully automated system, and thus, while much other data were available, only these three have been used in the program development.

The input data set was manipulated somewhat to ensure that sufficient variation in force levels and blade angles were included in the data set to test the full range of output options. Some situations that need to be modeled were not measured in the field tests conducted earlier (Nixon and Potter, 1997) so for those situations, appropriate data were developed to provide as full a test as possible of the proposed system.

The code was developed and tested in a modular manner. At the highest level, the program can be considered to consist of three parts: input; rule checking; and output. The

coding approach (or pseudo-code as it is sometimes termed) in each of these three areas is presented below.

3.1 Input Management Section

The first stage of the program is to input data. In the test model, as indicated above, this is done from a data file, but in the real deployment, the information would be collected from sensors on the truck measuring forces on the blade and the angle of the blade. Most of the input data were taken from data collected during field tests by Nixon and Potter (1997). Typical horizontal and vertical force data from these tests are shown in Figure 3.1. The blade angle and force angle are shown in Figure 3.2. The concept of force angle was developed by Nixon and Frisbie (1993). It is defined as:

$$ForceAngle = \arctan\left(\frac{F_y}{F_x}\right) \quad (3.1)$$

where F_y and F_x are the vertical and horizontal forces respectively. This gives a good measure of the efficiency of the cutting underbody blade, since a lower value of force angle indicates a given value of horizontal force (proportional to the depth of ice cut) is obtained for less vertical force. Typical values of force angle are in the range of 70 to 80 degrees.

As can be seen, all these values vary at a fairly rapid rate over time. Since the ability of the computer system to respond to these changes is almost instantaneous, the input data must be smoothed, otherwise the output signals will also vary rapidly, and may cause instability in the hydraulic system as a result.

The data collected from the trucks in the various field tests comprised horizontal load, vertical load, and blade angle. In all three cases, the signals were in the range of 0 to 5 volts, and were collected at a rate of 25 Hertz. After collection, the voltage values were converted to forces and angles as appropriate. It is these force and angle values that will be used in this study, solely because they have more meaning than mere voltage values, although in practice, it is the voltage values alone that would be used.

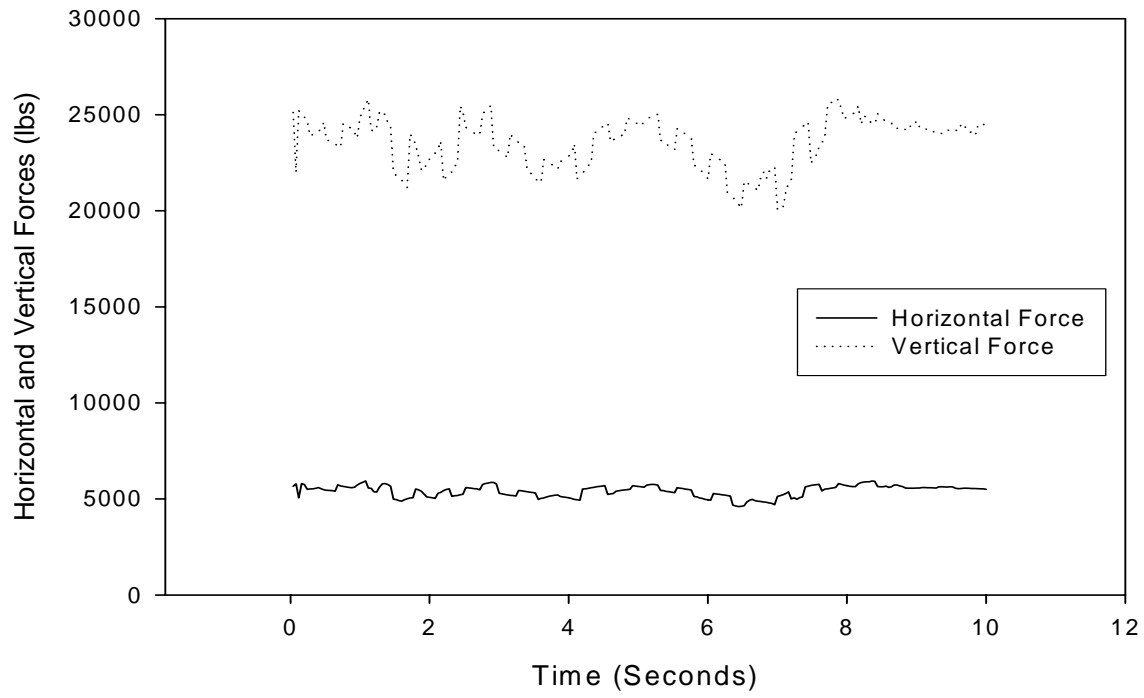

Figure 3.1: Typical Horizontal and Vertical Force Data for an Underbody Plow

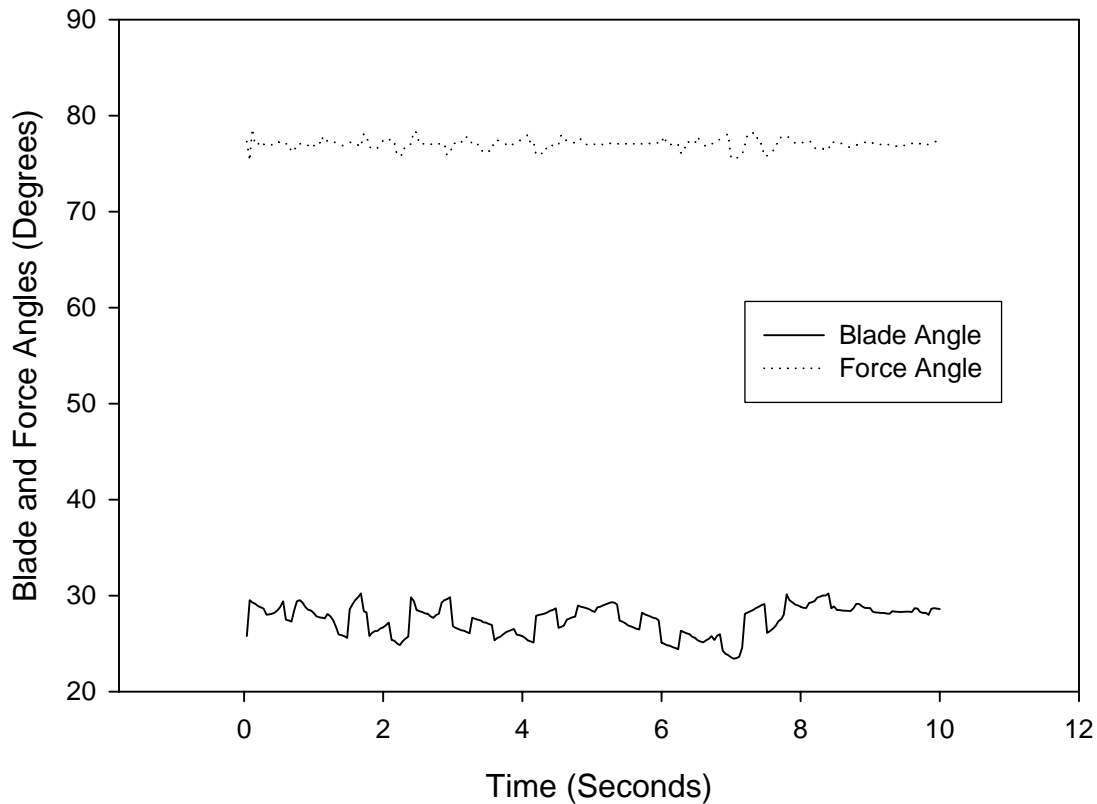

Figure 3.2: Typical Blade Angle and Force Angle Data for an Underbody Plow

In order to smooth the data it was decided to calculate a ten point moving average for all the input data. Of course, the data could be averaged over any number of points and the choice of ten rather than say five, twenty or one hundred is arbitrary. However, while it is clear that some smoothing will be needed, it is not clear how much, and this cannot be determined until the responsiveness of the hydraulic system to the feedback signal has been observed. Thus the final data smoothing may well be different from that used here, but the selection of a ten point moving average allows for the concept of smoothing to be tested and evaluated. Smoothed data are shown in Chapter 5.

A number of conditions likely to be met in the field had to be tested in the bench test modeling. This meant a number of data sets had to be developed. Table 3.1 lists the conditions that had to be tested. For each of these, a single data set was developed. It should be noted that it was decided not to test two of the rules listed in Table 2.1, namely rule 1 “When the plow is “on” it should be scraping “ and rule 3 “If the panic button is

pushed, then the plow should disengage quickly and safely.” All these require in practice is in the first instance a check that the forces are non-zero, and in the second an extra data channel that is either off or on. When the latter is on, it should result in the blade disengaging, all hydraulic levels being reduced to zero as rapidly as possible, and the blade being raised to an angle of 90 degrees (or as close to horizontal as feasible for the truck). The programming of this is trivial but the deployment of such a system poses a number of issues that come under the area of system integration. As such, this part of the development was not considered in this study.

Table 3.1: Conditions to be tested

Rule #	Condition	Data to test
1	When the plow is “on” it should be scraping	Not tested
2	The operator should be able to control the truck	F_y less than 29,000 lbs
3	If the panic button is pushed, then the plow should disengage quickly and safely	Not tested
4	The down force should not be too high	See rule 2
5	The down force should not be too low	F_y greater than 20,000 lbs
6	The blade should operate close to the vertical	See rule 7
7	The blade should be at an angle between 0 and 30 degrees	Blade angle is the measure
8	The ratio of horizontal to vertical force should be high	Force angle less than 80 degrees
9	The horizontal force should be high	F_x greater than 2000 lbs

However, for each of the conditions to be tested, an appropriate data set was required. In some cases, a single data set could be used to test a number of the conditions. However, a total of 5 different data sets (in addition to the base data set described above) were developed. Table 3.2 shows which data sets (labeled A through F) were used for which conditions. Figures 3.3 through 3.8 show the input data sets A through F respectively.

Table 3.2: Data Sets used for Condition Testing

Rule(s) to be tested	Data set description
2, 4	Vertical force moves above 29,000 lbs during test period (A)
5	Vertical force moves below 20,000 lbs during test period (B)
6, 7	Two data sets. In one, the blade angle exceeds 30 degrees at some points. In the other, it goes below 0 degrees at some points (C, D)
8	The force angle moves above 80 degrees during test period (E)
9	Horizontal force goes below 2,000 lbs during test period (F)

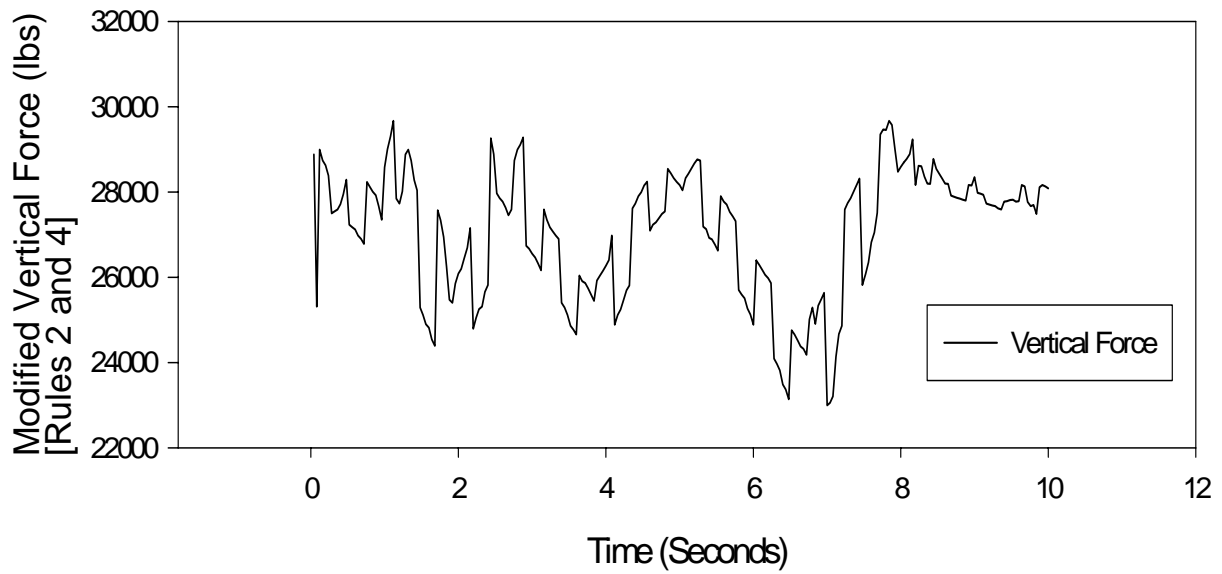

Figure 3.3: Vertical Force Data Set A to Test Rules 2 and 4

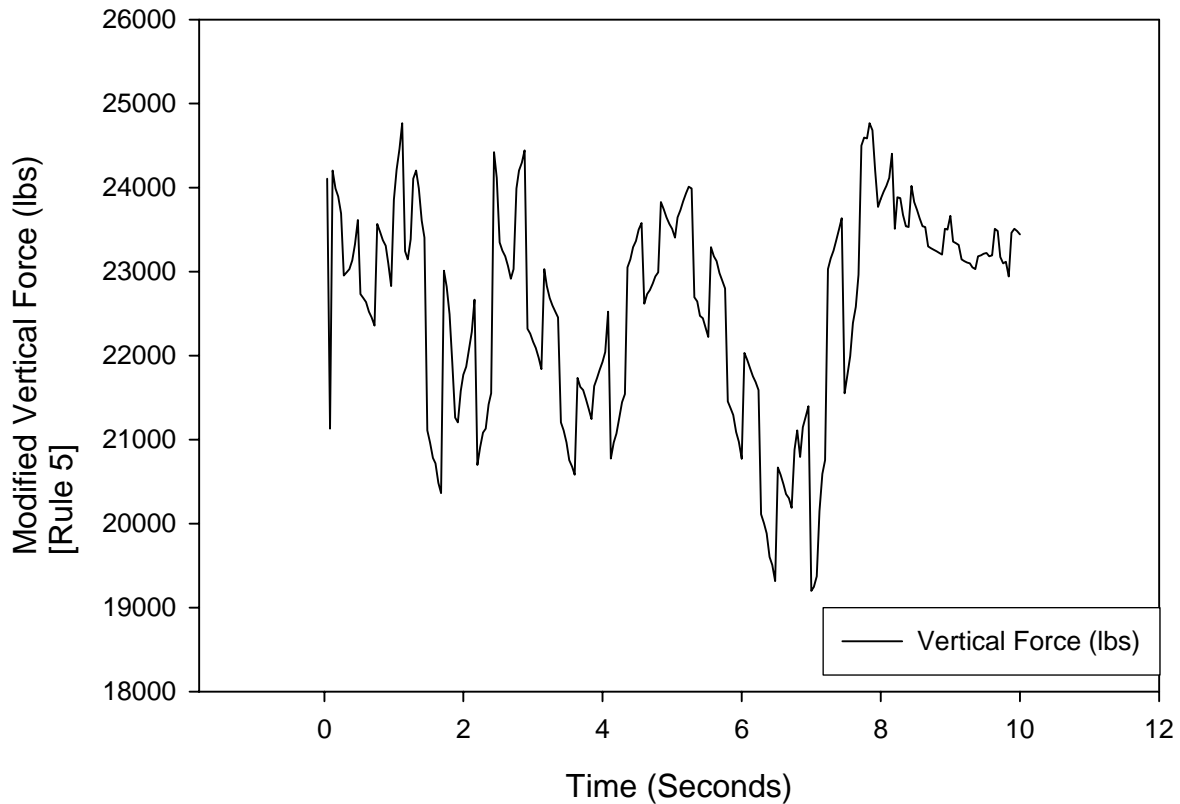

Figure 3.4: Vertical Force Data Set B to Test Rule 5

The pseudo-code for the input module is straightforward. Data must be read from an input file into arrays within the program. Each set of values (horizontal force, vertical force, and blade angle) is then smoothed using a ten point moving average, and the result stored in a new array. This array must then be made available to the next module, for rule testing.

3.2 Rule Checking Modules

Each of the data values must be checked against the rules that have been expressed in tables 2.1 and 3.1. It will be noted that in some cases, the ratio of horizontal force to vertical force must be used, and so a first step in this series of modules is to calculate this ratio value (using smoothed values for both horizontal and vertical forces) and store it in an array. Then a series of modules compare the values with the limits expressed by the rules.

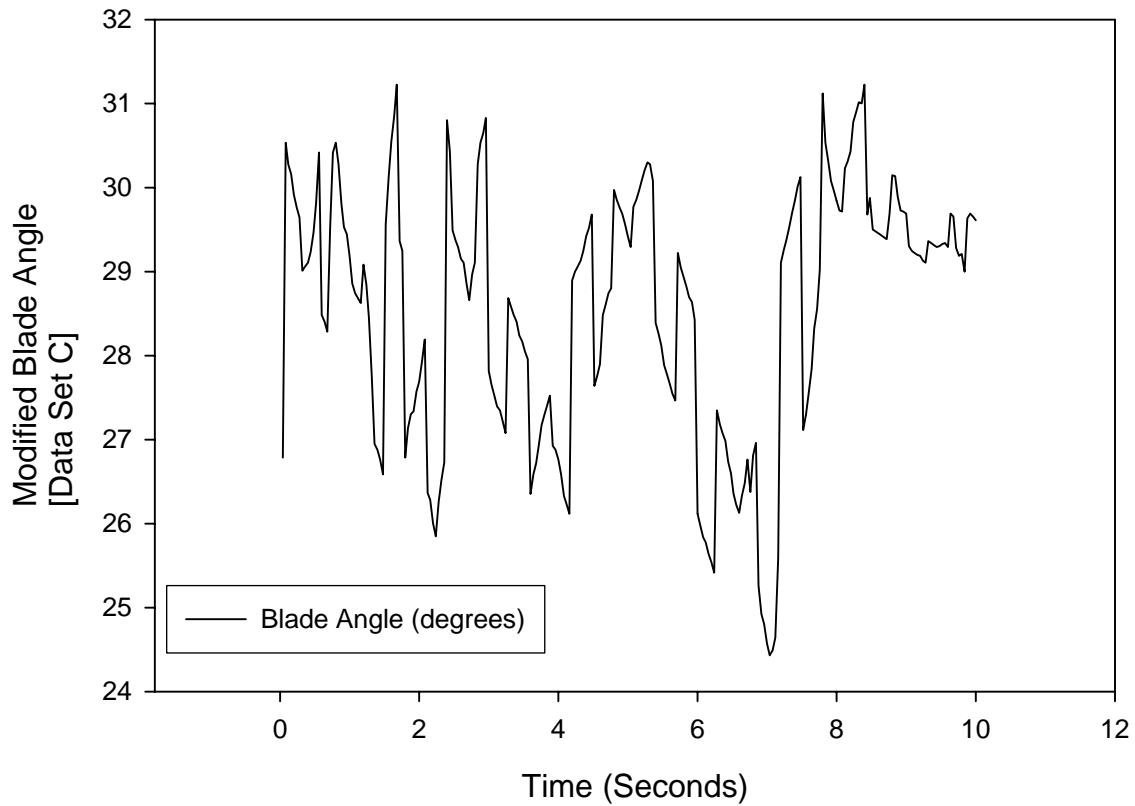

Figure 3.5: Blade Angle Data Set C to Test Rules 6 and 7

It is at this stage of the process that the “fuzziness” is applied to the system. The rules are not treated as absolute values, but rather, as indicated in figure 2.2, they fall into a range. Thus a given value of horizontal force may trigger an exception at one time, yet at another time, that same value will not trigger the exception. This leads to a more robust system.

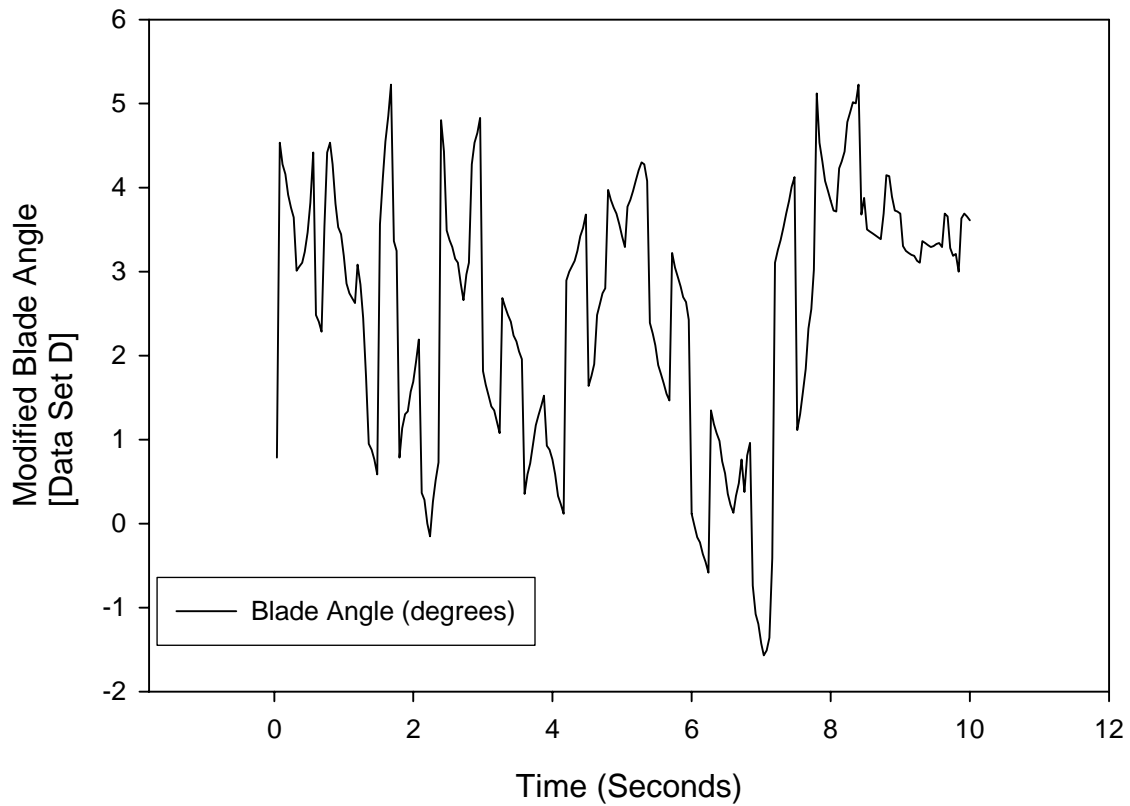

Figure 3.6: Blade Angle Data Set D to Test Rules 6 and 7

The approach taken in the rule setting part of the program is to develop a series of evaluative statements, which test whether or not a given data value has exceeded the fuzzy limit set for it by the rule being tested. The results of this test will be a zero if the rule has not been violated, or 1 if the rule has been violated. These values will be placed into a results matrix which is then passed to the third part of the program, the output.

3.3 Output Module

The purpose of the output module is to take the results of the rule checking modules and use those results to develop commands that would be sent to the hydraulic control system to modify the behavior of the system.

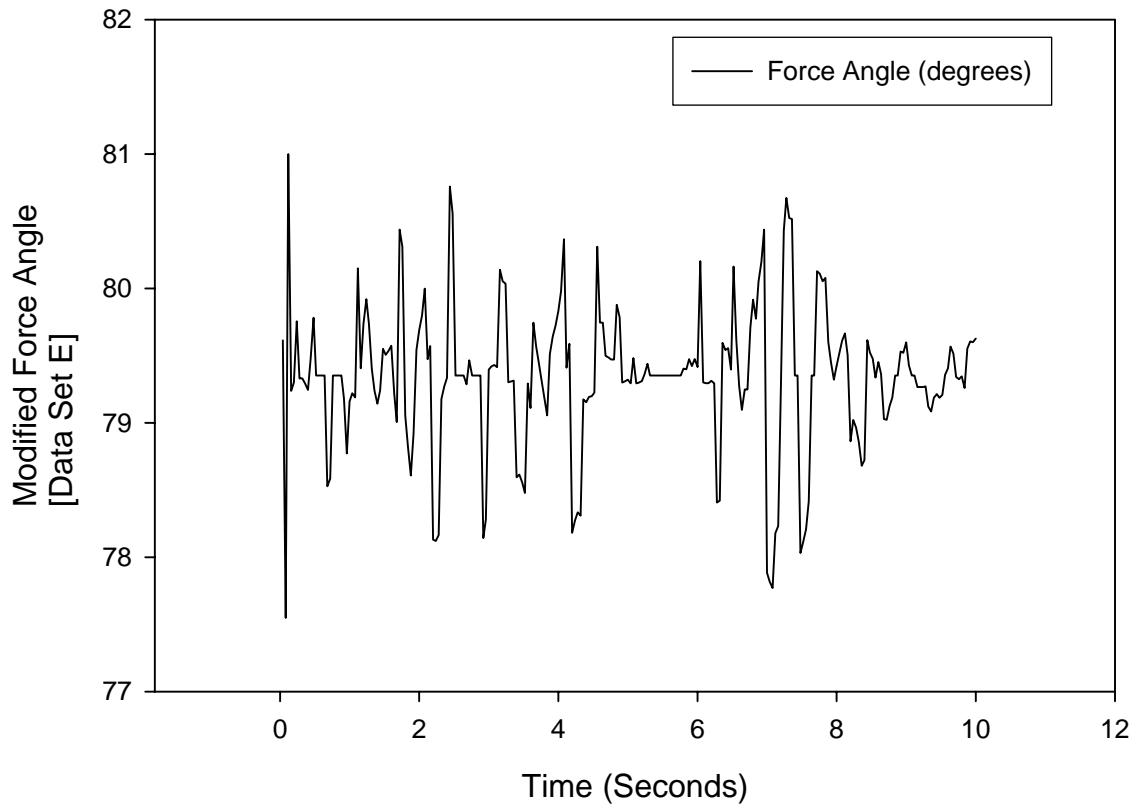

Figure 3.7: Force Angle Data Set E to Test Rule 8

In essence, the output module will examine the matrix array generated by the previous modules, and then generate an appropriate signal. The challenge here is that the various forces and angles considered by the rule modules are not all directly controllable. The hydraulic system can control two of them directly: the vertical force, and the blade angle. Thus if any of rules 2, 4, 5, 6, and 7 are violated, the system can directly change either the vertical force or the blade angle. However, the horizontal force is a function of how much ice is being cut. If it gets too low (rule 9), then one of two things may be happening. Either the vertical force is too low to allow the cutting edge to cut ice, or the cutting edge has become blunt, thus necessitating a change in blade angle.

This means that when rule 9 has been violated (horizontal force below 2,000 lbs) the output module must first check and see whether the vertical force has dropped below 20,000 lbs at the same time as the horizontal force has triggered the low value state. If it has, then the command to be sent is to increase the down pressure. If the vertical force is

not below the 20,000 lb level, then the system must adjust the blade angle from either 30 to 15 degrees or from 15 to 30 degrees, because the blade has most likely worn blunt and needs a change in blade angle to sharpen itself again (common practice among experienced underbody plow operators, as noted by Nixon and Potter, 1997). Thus in this circumstance, the output module must adjust the blade angle, and not change the vertical force.

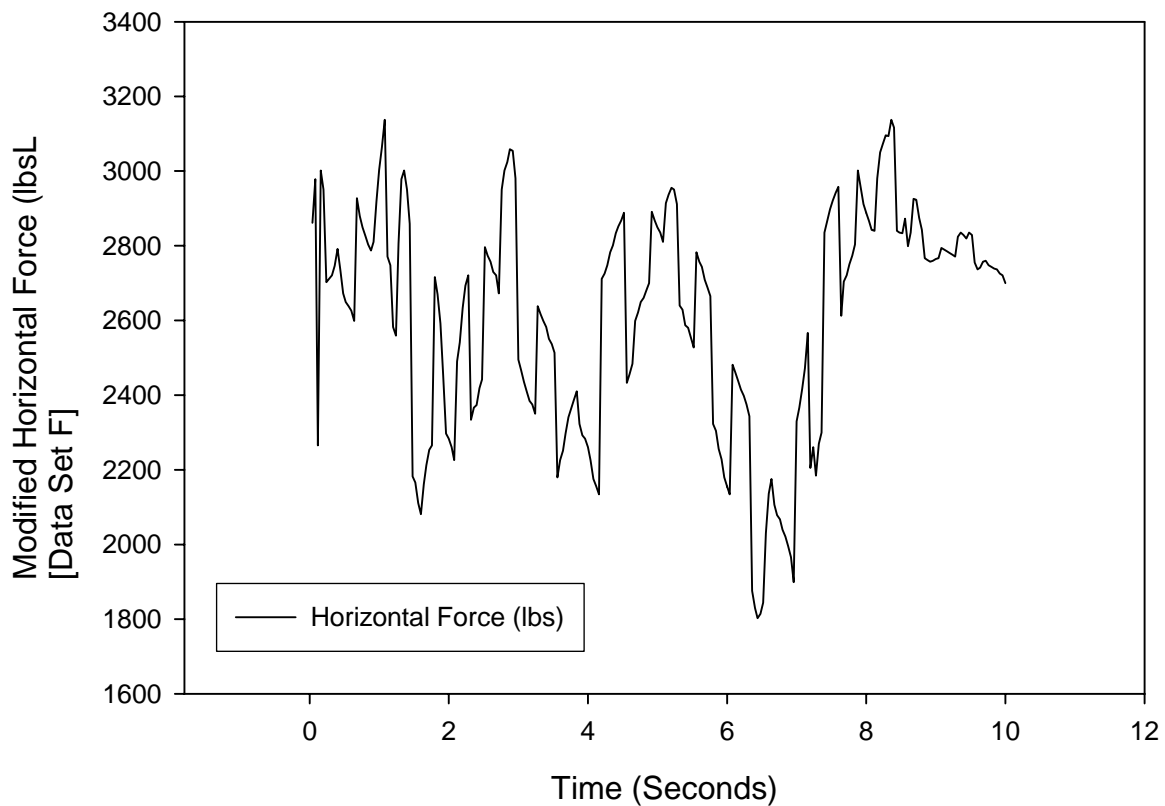

Figure 3.8: Horizontal Force Data Set F to Test Rule 9

So, too, the force angle is a measure of the ratio of the vertical and horizontal forces. If it gets too large (thus violating rule 8) it could be because the vertical force is too great or because the horizontal force is too small. In the first case, the system simply needs to reduce the vertical force. In the second case, the system will need to perform both checks (of a low vertical force and of the blade angle setting) in the case considered above. If vertical force is too low, then this must be increased, but if it is not, it is most likely that the blade has become worn and is thus not cutting well (see Nixon 1993;

Nixon and Chung, 1992; Nixon et al., 1996). In this case the blade angle must be adjusted as indicated above.

4. CODE DEVELOPMENT

In this chapter the coding approach is discussed in greater detail. The chapter first presents the information on how the standard MatLab coding was done, and then discusses the use of the Simulink© program.

4.1 MatLab Program Development

As indicated above, there are three main phases to the MatLab programming: input, rule checking, and output. The input module essential reads data from an input file, calculates a ten point moving average for each data set, and then outputs those data to another file for use in the rule checking module. Figure 4.1 illustrates this schematically. This part of the process is very straightforward.

In the rule checking module, the various rules to be checked are considered at each time step. A number of sequences can be used for this, but it is in general best to start with the simplest steps and then move to greater complexity. Accordingly, the module checks blade angle first. If it exceeds 30 degrees, it is set to 29 degrees. If it falls below zero degrees it is set to 16 degrees. If either of these two conditions is violated, the program moves to the next time step.

The next stage is to check the horizontal force. As noted in chapter 3, the horizontal force is not directly controlled by the hydraulics. Thus, if the horizontal force has fallen below 2,000 lbs, first the vertical force is checked. If this is less than 20,000 lbs, it is increased to 25,000 lbs (the mid-part of the vertical force operating range). If the vertical force is at an appropriate level, the blade angle is changed (the assumption being that the horizontal force is low because the blade has become blunt and is thus not cutting ice). First, the blade angle is checked to see if it is greater than 22.5 degrees (the mid-point of the operating range). If it is greater than this, it is set to 15 degrees. If it is less than 22.5 degrees, it is increased to 29 degrees. If the horizontal force is too low, then the program, having issued corrective measures, moves to the next time step.

Smoothing/Input Module

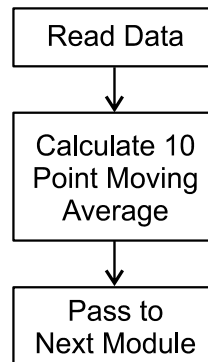

Figure 4.1: Smoothing Process

If the horizontal force is sufficiently large, then the force angle is checked. If this exceeds 80 degrees, then exactly the same checks are run as for the horizontal force violation, and again, the program will proceed to the next time step. However, if the force angle is within acceptable limits, the vertical force is checked for both exceeding the maximum allowed value (29,000 lbs) or falling below the minimum value (20,000 lbs). If either condition is violated, the vertical force is set to 25,000 lbs, and the program moves to the next time step. If the vertical force falls within these limits, then the program issues no corrective commands, and moves to the next time step. Figure 4.2 illustrates this schematically.

It will be noted that nowhere in figure 4.2 is the notion of fuzziness indicated. The checks, as written above and shown in the schematic, can be performed either deterministically or with fuzziness included. The fuzziness can be incorporated by the use of certain sub-routines available in the MatLab program environment. While these subroutines are in and of themselves rather complex, they are available as a pre-packaged feature of the program environment, and it must be made clear that they were not developed in this study, but rather simply used by the study in the program development.

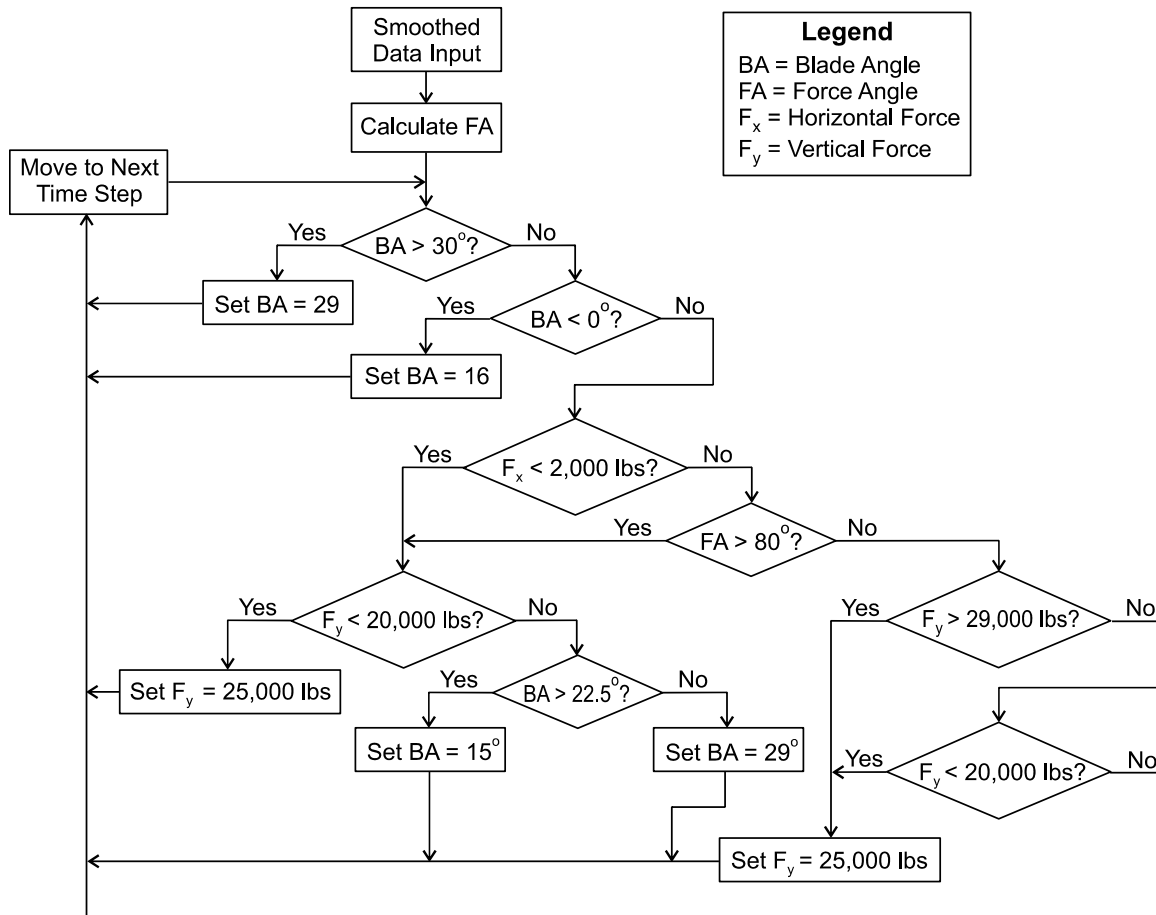

Figure 4.2: The Rule Checking Module

The output module simply takes the results of the rule checking and turns these into particular commands that would be issued to the hydraulic control system. In essence, this is already included in figure 4.2. To make the steps more explicit, whenever one of the rules is violated, a value in an array, corresponding both to the time step where the violation occurred and to the nature of the violation is changed from zero to one. In the output module, this array is read and the indications of particular violations are turned into specific commands issued to the control system.

4.2 Simulink© Program Development

In developing the simulation of the system, some simplifying assumptions were required to make the program development tractable. A number of these concerned the

way in which the system responds to input commands from operators. To that end, it is assumed that the automated system, at first, lowers the blade to touch the road surface. The road surface, in turn, gives a reaction that is measured by the automated system. It is by this reaction that the system can determine the correct down force to apply, which in turn determines the depth for the blade. The final down force is determined after a series of actions involving lowering and raising the blade. As noted in the previous studies, it is critical that a clearance angle is maintained on the cutting edge. Experienced underbody plow operators maintain this clearance (as the blade wears) by periodically adjusting the angle of curl of the blade. It is such expertise that the computer controlled system must capture.

4.2.1 Control system process

From the above, it is clear that the system will use a series of trials (adjusting down force and thus raising and lowering the blade) to decide on the optimal blade depth and vertical force. The force exerted by the road surface on the blade is used in this simulation as the controlling factor. This can be used as a feedback in a classical control system process.

4.2.2 Simulink

Simulink is a software package that enables us to model, simulate and analyze systems whose outputs change over time. These systems are dynamic and simulating them is a two-step process. First, a graphical model of the system to be simulated is developed, using Simulink's model editor. The model depicts the time-dependent mathematical relationships among the system inputs, states and outputs. Then Simulink is used to simulate the behavior of the system over the specified time-span.

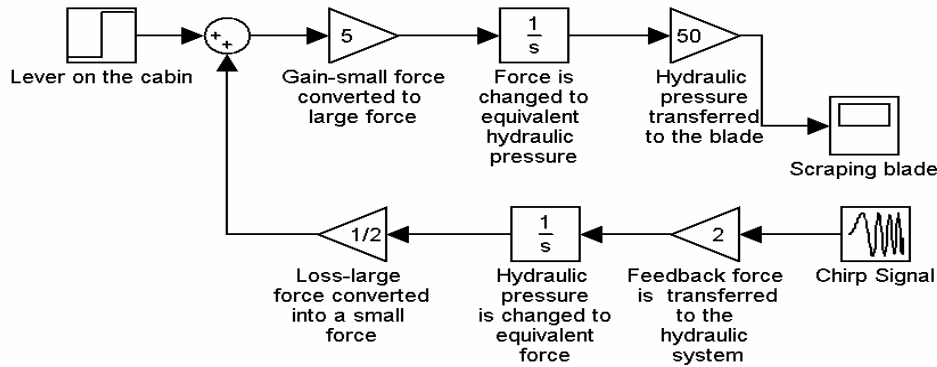

Figure 4.3: Simulink model

Figure 4.3 shows the first step, i.e. designing the model. The system is modeled in a simple manner as a lever in the operator cab that is to be automated in its operation. The system then begins with the lever used to control the blade. This is modeled as a step function as it is assumed that the optimum down force and depth are achieved by a series of trial and error attempts. The displacement of the lever is multiplied by a gain factor and using a transfer function this is converted into hydraulic force. The hydraulic force is again multiplied by a gain factor and is transmitted to the blade.

As this is modeled as a closed system we need to specify a feedback. The forces present on the blade as the blade touches the road surface are modeled as a chirp signal. The forces from the blade are de-amplified across the model using de-gain blocks and transfer functions. The signal is fed to the sum block and the next input is the resultant of the input signal and the feedback signal.

There are three variables of interest while developing this model- horizontal force, vertical force and displacement of the blade (lowering of the blade). From previous studies, it has been found that the quantity of ice removed is directly proportional to the horizontal load and thus the horizontal force is a measure of the effectiveness of the blade (Nixon and Potter, 1993). Also, the same researchers have shown that a high vertical

download is a cause of concern because it removes traction from the trucks axles and makes the truck rest predominantly on the cutting edge.

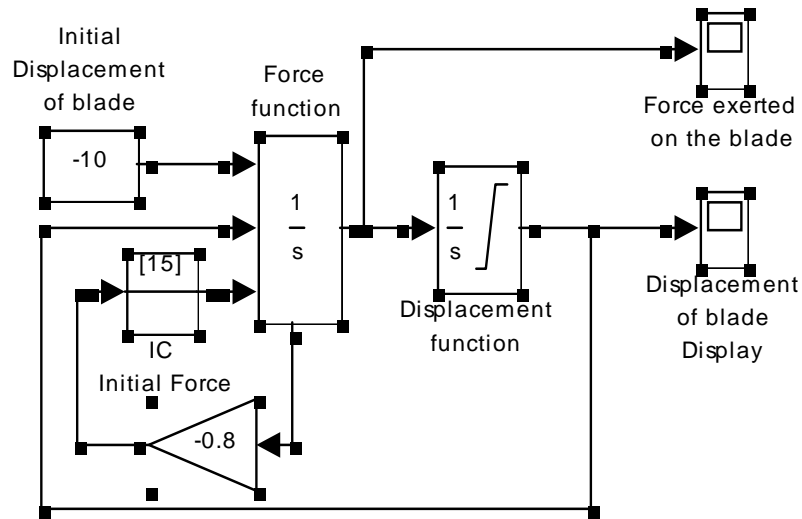

Figure 4.4: Simulink model with force and displacement as variables

Figure 4.4 shows the model with force applied on the blade and displacement of the blade as the major variables. Force and displacement functions have been integrated with respect to time. The lower and upper limits of force function integration range from negative to positive infinity. The parameters of the force and displacement functions are shown in figures 4.5 and 4.6. The outputs of both functions are obtained by the scope variables, shown at the right hand corner of figure 4.4.

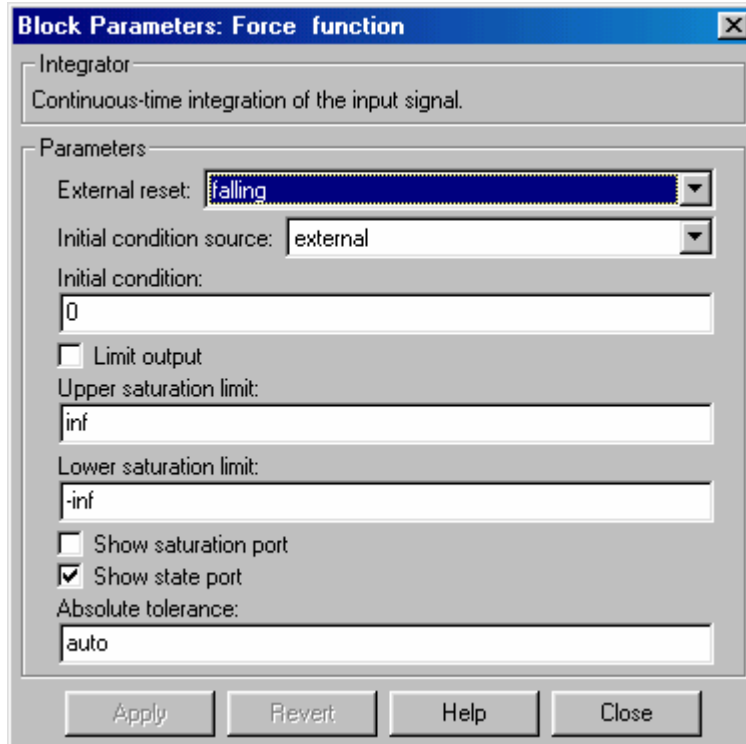

Figure 4.5: Parameters of the force function

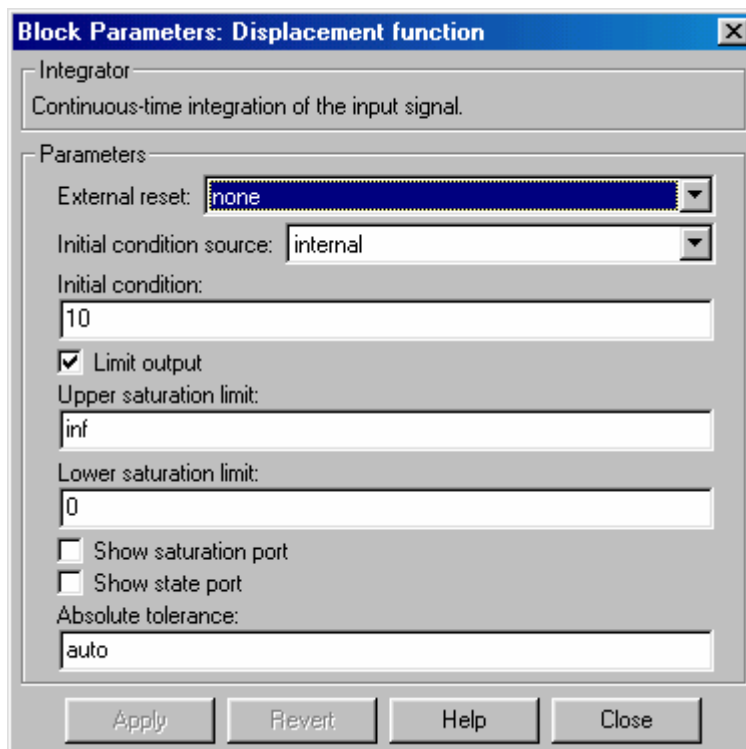

Figure 4.6: Parameters of the displacement function

The results of this simulation are presented in Chapter 5.

5. RESULTS

This chapter presents the results from the programming described previously, and discusses, where appropriate, those results. The chapter is presented in two parts: results from basic MatLab programming, and then results from the Simulink© program.

5.1 MatLab Program Results

During the input process of the program, all the data sets were smoothed. Figure 5.1 shows the impact of smoothing on the raw data, in this case showing how the vertical force input data were smoothed by the use of a ten point moving average. As noted above, the selection of the range of the moving average would be an issue that could only really be addressed during full field implementation.

Each of the test conditions were run through the program to determine the extent to which the notional output was adjusted by the program. In all cases, the output adjusted to reflect the appropriate violation of the limiting rules. Figure 5.2 shows an example for the violation of rules 2 and 4 (the vertical force exceeding 29,000 lbs). In this case, if these rules were violated, the program reset the vertical force to a value of 26,000 lbs. It can be seen that this does not happen very often for the vertical force set applied. This may reflect a combination of the smoothing and the fuzzy logic application.

All possible violation conditions were tested, and Table 5.1 lists the results. It should be noted that only the vertical force and the blade angle were considered to be adjustable by the program. On that basis, the results clearly indicate that the program can identify rules violations, and generate appropriate commands in response to those violations. On the basis of these results, it is apparent that the use of MatLab to model a computer controlled underbody plow has provided positive results. The extent to which such a plow could actually be implemented using this as a basis for the control system can be determined by appropriate field tests.

Table 5.1: Results of tests of data sets that violate operational rules

Condition	Output Value of Blade Angle (degrees)	Output Value of Vertical Force (lbs)
Blade angle exceeds 30°	29°	Not changed
Blade angle less than 0°	16°	Not changed
Fx less than 2,00lbs and Fy less than 20,000 lbs	Not changed	25,000 lbs
Fx less than 2,000 lbs, Fy greater than 20,000 lbs and blade angle greater than 22.5°	15°	Not changed
Fx less than 2,000 lbs, Fy greater than 20,000 lbs and blade angle less than 22.5°	28°	Not changed
Force angle greater than 80° and Fy less than 20,000 lbs	Not changed	25,000 lbs
Force angle greater than 80°, Fy greater than 20,000 lbs and blade angle greater than 22.5°	15°	Not changed
Force angle greater than 80°, Fy greater than 20,000 lbs and blade angle less than 22.5°	28°	Not changed
Fy greater than 29,000 lbs	Not changed	26,000 lbs
Fy less than 20,000 lbs	Not changed	24,000 lbs

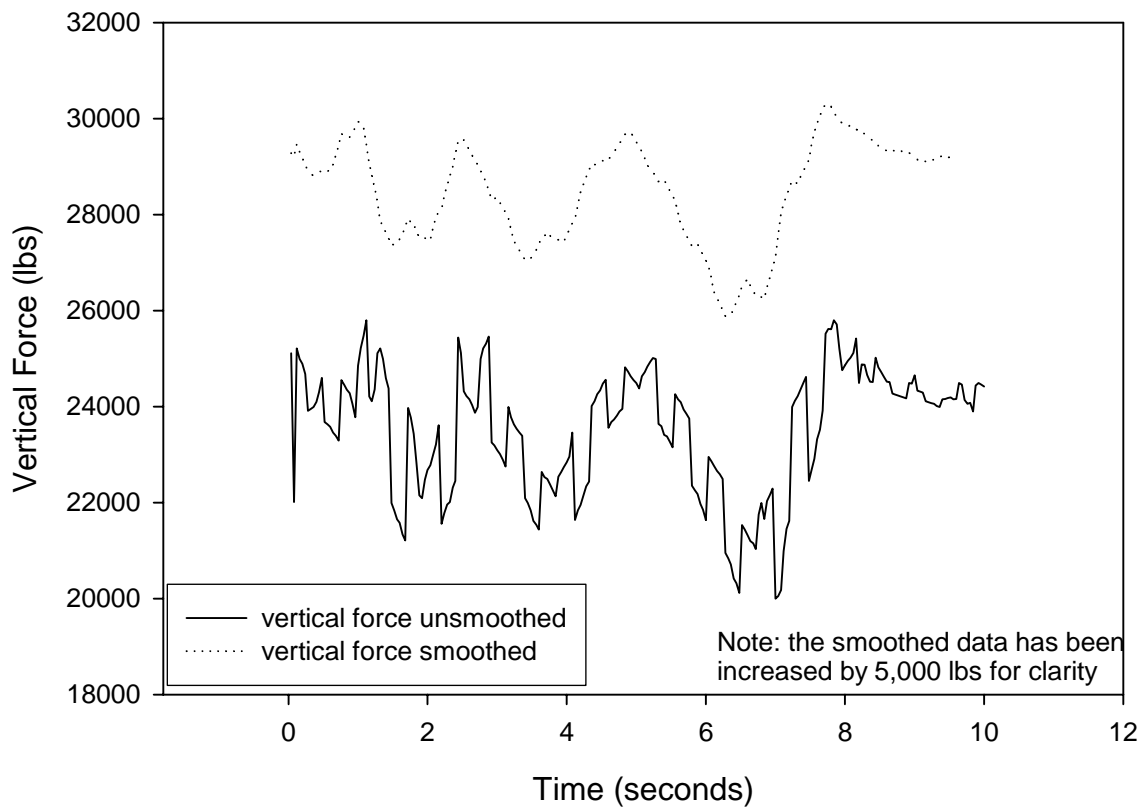

Figure 5.1: Smoothed Input Data

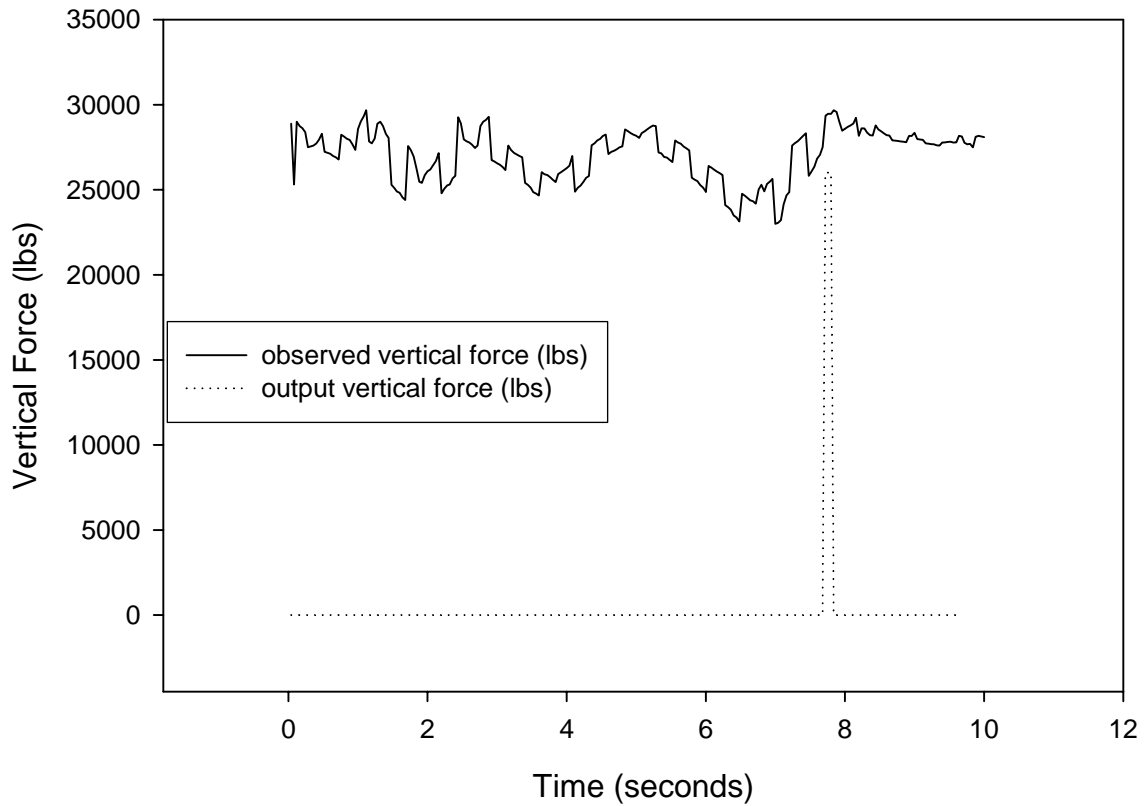

Figure 5.2: The Output Vertical Force in Response to a Force Violation

5.2 Simulink Program Results

The force function was assumed to fluctuate over the actual required force for sometime and finally settle at the required force. The force function has been modeled in Figure 5.3. Here the force function fluctuates between +15 and -20 and finally settles at zero which is the optimum force required to scrap the ice. The fluctuation stands for the different pressures applied on the blade due to the adjustments made by the maintenance personnel.

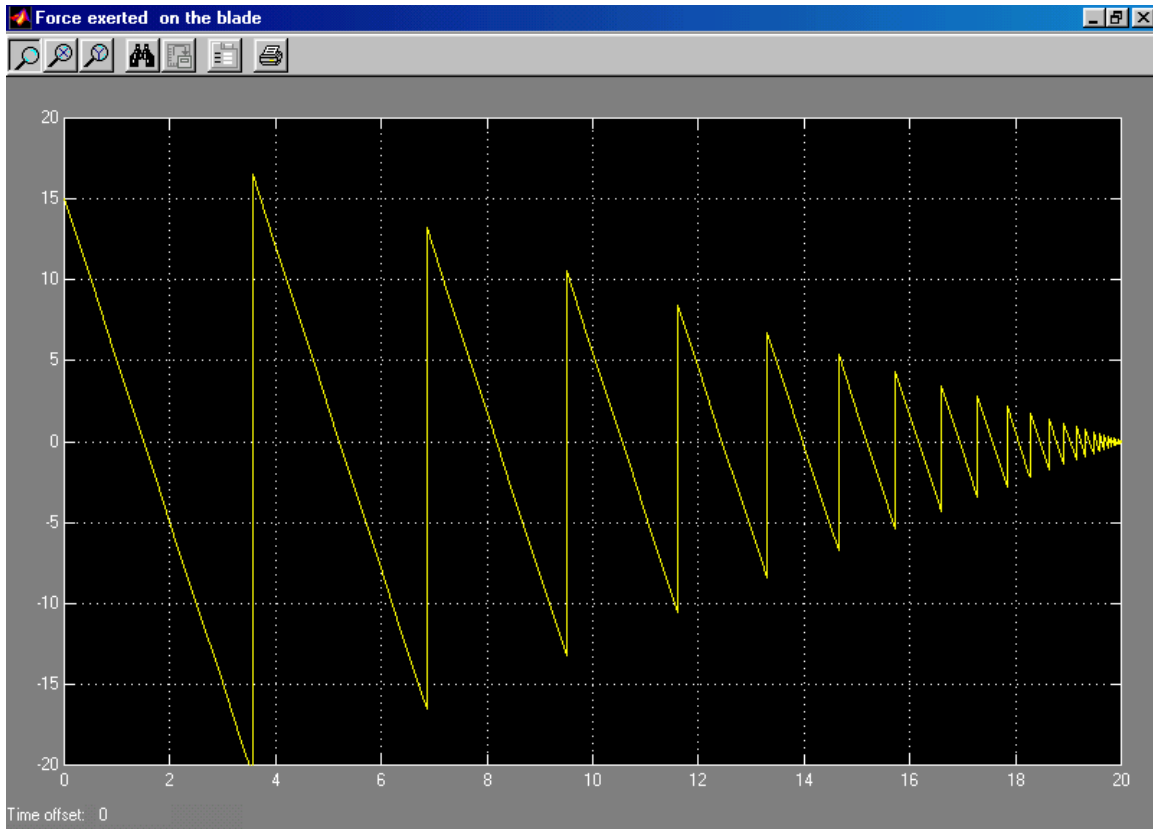

Figure 5.3: Force function

Figure 5.4 shows the displacement of the blade. It should be noted that the displacement function and the force function are related. The force function fluctuates over positive and negative regions and finally settles to zero while the displacement function fluctuates only over the positive region and finally tends to zero. This zero for the displacement function denotes the optimum depth required for the blade to scrap the ice.

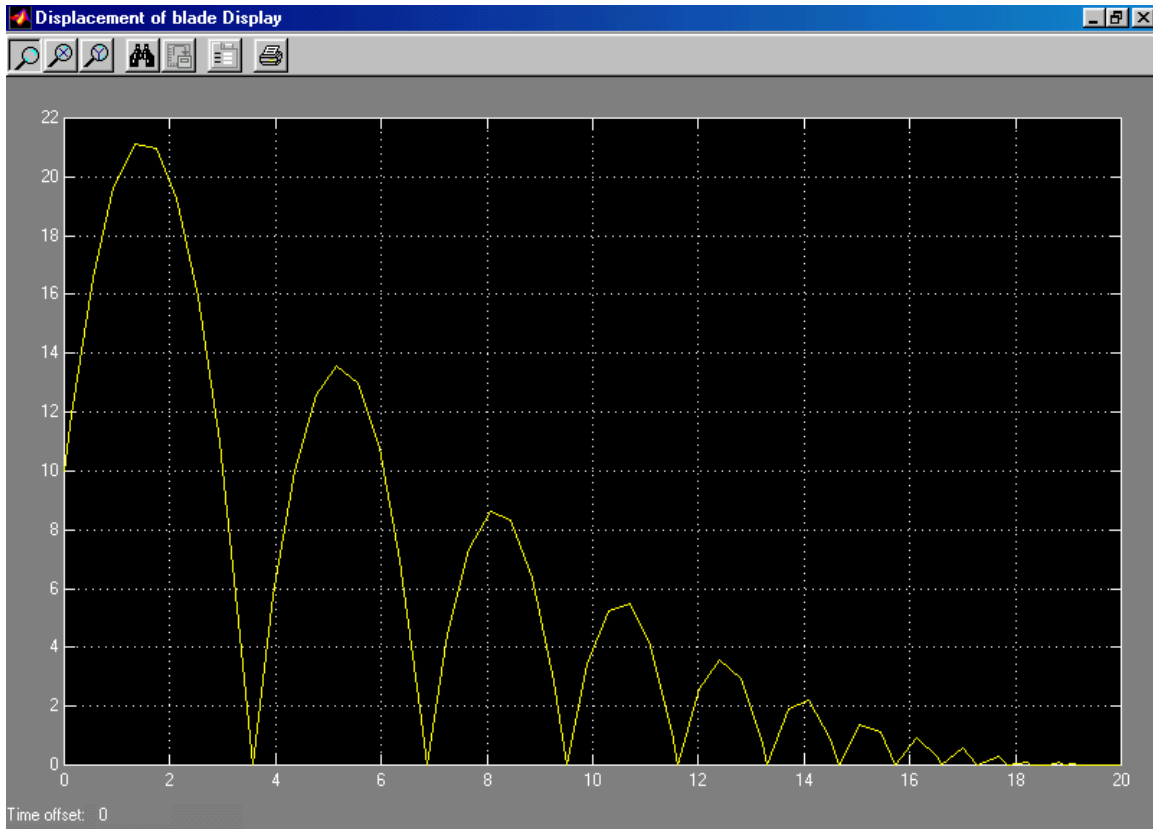

Figure 5.4: Displacement function

The real life example of scraping ice using an underbody plow has been modeled here using a simulation tool, Simulink. Two functions while scraping ice, i.e, force exerted on the blade to scrap ice and displacement of the blade are considered in this simulation. These functions have been found to be the most important while simulating the scraping of ice using an underbody plow.

The outputs have been displayed as graphical outputs, one as a force function and the other as a displacement function. The force function tends to fluctuate within a positive and negative range before settling to zero, which is the required optimum force. The displacement function, on the other hand, tends to fall from a positive range and settles to zero, which is the optimum displacement.

5.3 Implications of Results on the Deployment Decision

The results of the two simulations presented in this chapter make it clear that it would be possible to develop an automated system that would control an underbody plow, and provide a level of operational skill that would likely be competent if not brilliant. The tests conducted and reported herein do not allow for an evaluation of the skill of the automated system, since that would depend significantly on the implementation and integration of the automated system. Nonetheless it is clear that automation is possible and feasible.

The next issue is then to consider whether implementation of an automated underbody plow is desirable. Two arguments can be made in favor of such a system. The first is that an automated system would likely provide an acceptable skill level for underbody plowing. That is, while the plow performance would likely not be optimal at all times, it would be safe, and reasonably effective, without causing undue wear on the equipment. This argument has particular relevance for any organization that expects to lose through retirement or job changes the most skilled group among its snow plow operators. The extent to which such a situation might be relevant in Iowa or in other organizations is beyond the scope of this work.

The second argument in favor of an automated underbody plow system is one of safety. The snow plow cab is becoming an increasingly complex place, with multiple equipment requiring operation often under extremely stressful and hazardous conditions. The automation of one such piece of equipment would reduce the operational burden on the snow plow driver, and would thus tend to increase safety. However, it should be noted that while such a result seems likely, the human factors aspects of operating an automated versus a regular underbody plow were not considered in this study.

Two arguments can also be made against the development and implementation of an automated underbody plow system. The first relates to safety. If the plow automatically adjusts the loads and angles of the underbody plow this will likely impact the dynamic performance of the snow plow. Under certain, extreme, conditions it is possible that such automated changes might render the truck temporarily out of control (although this is unlikely). The use of such an automated system should thus only be

considered if prototype operation indicates clearly that such unexpected losses of stability have been themselves controlled and rendered extremely unlikely or impossible.

The second concern with using such a system is likely to be cost. No such system currently exists, and thus it would need to be developed. Such new technology is likely to be expensive to purchase, although the price may in essence be recovered over time by improved performance resulting in a higher level of service to the traveling public.

This second concern raises the question of who should develop such a system. If it is developed by a Department of Transportation, then significant costs would be sunk into the development and all the risk would be taken by the Department. If, instead, the task is taken on by a private vendor, the challenge of the competitive bid process may make it difficult to recover the vendor's investment. Perhaps, if such a system is deemed worthy of further exploration, it would be a candidate for some sort of joint venture between a Department and a vendor. Such agreements are relatively common in Europe (Smithson, 2005, personal communication) but are very rare in the United States.

6. CONCLUSIONS

The purpose of this study has been to examine whether the development of a computer controlled underbody plow is feasible. The study has presented the three steps that would be needed to implement such a system (electronic control of hydraulics, computer coding of the expert system, and system integration) in concept. The computer control concept has been tested in two ways, using both MatLab and the Simulink simulation environment. Details of the coding have been provided. The results of the computer testing and simulation indicate that a fully automated, computer controlled underbody plow is indeed possible. The issue of whether the next steps toward full automation should be taken (and by whom) has also been considered, and the possibility of some sort of joint venture between a Department of Transportation and a vendor has been suggested.

7. REFERENCES

Cox, E. (1994). "The Fuzzy Systems Handbook," AP Professional, Chestnut Hill, MA, U.S.A.

Kosko, B. (1997). "Fuzzy Engineering," Prentice Hall, Upper Saddle River, NJ, U.S.A.

Nixon, W. A., "Improved Cutting Edges for Ice Removal," National Research Council, SHRP Report, SHRP-H-346, 1993, 98 pages.

Nixon, W. A. and C.-H. Chung, "Development of a New Test Apparatus to Determine Scraping Loads for Ice Removal from Pavements," Proc. 11th IAHR Ice Symposium, vol. 1, pp. 116-127, Banff, 1992.

Nixon, W.A., and Frisbie, T.R. (1993). "Field Measurements of Plow Loads during Ice Removal; Operations: Iowa Department of Transportation Project HR 334," IIHR Technical Report # 365, November 1993, 126 pages.

Nixon, W. A., T. J. Gawronski, and A. E. Whelan, "Development of a Model for the Ice Scraping Process: Iowa Department of Transportation Project HR361," IIHR Technical Report # 383, October 1996, 57 pages.

Nixon, W. A., and J.D. Potter (1997). "Measurement of Ice Scraping Forces on Snow-Plow Underbody Blades: Iowa Department of Transportation Project HR 372," IIHR Technical Report # 385, February 1997, 70 pages.

APPENDIX A: PROGRAM LISTINGS

The following section includes listing of all MatLab programs used in this study.

A.1: Program to test violation of Vertical Force Rules (2 and 4). In this case, the vertical force exceeds 29,000 lbs. Lines that begin with a % symbol are comment lines.

```
%first enter the input data
clear
input = [0.04      5661.087866  28876.5      25.78577406  77.29499484;
0.08      5778.451883  25311.5     29.53472803  75.28968236;
0.12      5065.062762  28991.5     29.27698745  78.63967673;
0.16      5801.464435  28738.5     29.15983264  76.9302156;
0.2       5750.83682   28623.5     28.91380753  76.99010557;
0.24      5502.301255  28382       28.76150628  77.43169377;
0.28      5511.506276  27496.5     28.64435146  77.01945815;
0.32      5520.711297  27542.5     28.01171548  77.01949313;
0.36      5546.025105  27588.5     28.05857741  76.98300154;
0.4       5592.050209  27715       28.10543933  76.93653087;
0.44      5536.820084  27945       28.23430962  77.16414121;
0.48      5472.384937  28290       28.46861925  77.45850126;
0.52      5449.372385  27232       28.82008368  77.04040507;
0.56      5437.866109  27174.5     29.41757322  77.04040507;
0.6       5426.359833  27117       27.48451883  77.04040507;
0.64      5398.74477   26979       27.40251046  77.04040507;
0.68      5727.824268  26898.5     27.28535565  76.23999831;
0.72      5679.497908  26783.5     28.53891213  76.29533753;
0.76      5649.58159   28232.5     29.41757322  77.04040507;
0.8       5626.569038  28117.5     29.53472803  77.04040507;
0.84      5603.556485  28002.5     29.27698745  77.04040507;
0.88      5587.447699  27922       28.8083682   77.04040507;
0.92      5610.460251  27669       28.52719665  76.87397217;
0.96      5718.619247  27347       28.44518828  76.47825438;
1         5803.76569   28577.5     28.1874477   76.85409979;
1.04      5863.598326  29003       27.85941423  76.91137858;
1.08      5937.238494  29302       27.74225941  76.88324157;
1.12      5571.338912  29670       27.68368201  77.81446693;
1.16      5548.32636   27841.5     27.6251046   77.09213857;
1.2       5382.635983  27726.5     28.08200837  77.4149107;
1.24      5359.623431  28014       27.84769874  77.59163153;
1.28      5605.857741  28876.5     27.44937238  77.41497916;
1.32      5778.451883  28991.5     26.74644351  77.09008606;
1.36      5801.464435  28738.5     25.94979079  76.9302156;
1.4       5750.83682   28278.5     25.87949791  76.83687858;
1.44      5658.786611  28037       25.7623431   76.9325915;
1.48      4982.217573  25288.5     25.58661088  77.23416607;
```

1.52	4966.108787	25116	28.5623431	77.18956643;
1.56	4910.878661	24897.5	29.11297071	77.21983369;
1.6	4880.962343	24817	29.54644351	77.25528675;
1.64	4961.506276	24541	29.85104603	76.91137858;
1.68	5012.133891	24391.5	30.22594142	76.70434333;
1.72	5053.556485	27565.5	28.36317992	78.09476998;
1.76	5065.062762	27335.5	28.2460251	77.97096013;
1.8	5516.108787	26944.5	25.78577406	76.75214058;
1.84	5470.083682	26254.5	26.13723849	76.52590158;
1.88	5391.841004	25472.5	26.30125523	76.31891667;
1.92	5253.76569	25403.5	26.33640167	76.62163692;
1.96	5097.280335	25852	26.5707113	77.22436083;
2	5083.472803	26082	26.68786611	77.36657907;
2.04	5060.460251	26197	26.93389121	77.47541548;
2.08	5025.941423	26438.5	27.1916318	77.66833609;
2.12	5290.585774	26691.5	25.36401674	77.15915422;
2.16	5341.213389	27151.5	25.28200837	77.25273377;
2.2	5433.263598	24794	25.00083682	75.85559768;
2.24	5493.096234	25047	24.84853556	75.84473633;
2.28	5520.711297	25254	25.25857741	75.88836607;
2.32	5134.100418	25311.5	25.51631799	76.86984445;
2.36	5166.317992	25656.5	25.72719665	76.9618512;
2.4	5173.221757	25817.5	29.8041841	77.02367291;
2.44	5219.246862	29256	29.4292887	78.40612732;
2.48	5242.259414	28888	28.49205021	78.2122;
2.52	5596.65272	27968	28.3748954	77.04040507;
2.56	5573.640167	27853	28.29288703	77.04040507;
2.6	5557.531381	27772.5	28.15230126	77.04040507;
2.64	5529.916318	27634.5	28.10543933	77.04040507;
2.68	5520.711297	27450.5	27.85941423	76.97746963;
2.72	5472.384937	27588.5	27.66025105	77.15006709;
2.76	5750.83682	28738.5	27.96485356	77.04040507;
2.8	5801.464435	28991.5	28.10543933	77.04040507;
2.84	5824.476987	29106.5	29.27698745	77.04040507;
2.88	5858.995816	29279	29.53472803	77.04040507;
2.92	5854.393305	26737.5	29.65188285	75.86663157;
2.96	5780.753138	26668.5	29.82761506	76.00270587;
3	5295.188285	26553.5	26.8167364	77.08379792;
3.04	5267.573222	26461.5	26.65271967	77.10572638;
3.08	5235.355649	26323.5	26.52384937	77.11701624;
3.12	5210.041841	26162.5	26.39497908	77.1009661;
3.16	5184.728033	27588.5	26.34811715	77.80477688;
3.2	5175.523013	27347	26.21924686	77.72151999;
3.24	5150.209205	27174.5	26.07866109	77.70454608;
3.28	5437.866109	27071	27.68368201	76.99253888;
3.32	5417.154812	26979	27.57824268	76.99771136;

3.36	5398.74477	26898.5	27.48451883	77.00293549;
3.4	5382.635983	25403.5	27.40251046	76.30569369;
3.44	5350.41841	25288.5	27.23849372	76.3250042;
3.48	5336.610879	25116	27.16820084	76.26882094;
3.52	5313.598326	24863	27.05104603	76.19195992;
3.56	4979.916318	24771	26.95732218	76.98228459;
3.6	5025.941423	24656	25.35230126	76.80700448;
3.64	5051.25523	26036	25.58661088	77.42262111;
3.68	5097.280335	25909.5	25.71548117	77.25178584;
3.72	5141.004184	25863.5	25.94979079	77.12395069;
3.76	5164.016736	25737	26.17238494	77.00683834;
3.8	5187.029289	25599	26.28953975	76.88299461;
3.84	5210.041841	25449.5	26.40669456	76.75216226;
3.88	5122.594142	25921	26.52384937	77.19605573;
3.92	5092.677824	26036	25.92635983	77.32280139;
3.96	5083.472803	26151	25.87949791	77.39884675;
4	5060.460251	26266	25.7623431	77.50728298;
4.04	5025.941423	26404	25.58661088	77.65271722;
4.08	4975.313808	26979	25.32887029	78.02632115;
4.12	4956.903766	24886	25.23514644	77.09828394;
4.16	4933.891213	25116	25.11799163	77.26995742;
4.2	5511.506276	25242.5	27.89456067	75.90479455;
4.24	5525.313808	25472.5	28	75.99342835;
4.28	5548.32636	25691	28.05857741	76.05231538;
4.32	5582.845188	25806	28.12887029	76.02903067;
4.36	5601.25523	27611.5	28.2460251	76.86841759;
4.4	5633.472803	27726.5	28.42175732	76.84838604;
4.44	5651.882845	27899	28.51548117	76.88565322;
4.48	5667.991632	27991	28.67949791	76.89129989;
4.52	5688.702929	28152	26.64100418	76.91770028;
4.56	5233.054393	28244	26.758159	77.97173358;
4.6	5256.066946	27094	26.89874477	77.42366661;
4.64	5283.682008	27232	27.48451883	77.42172149;
4.68	5398.74477	27289.5	27.60167364	77.18296262;
4.72	5421.757322	27381.5	27.74225941	77.17195352;
4.76	5449.372385	27485	27.80083682	77.15572431;
4.8	5460.878661	27542.5	28.97238494	77.15548345;
4.84	5479.288703	28543	28.85523013	77.55099744;
4.88	5500	28439.5	28.76150628	77.46138011;
4.92	5691.004184	28324.5	28.69121339	76.9895747;
4.96	5667.991632	28232.5	28.5623431	76.99960662;
5	5649.58159	28163.5	28.42175732	77.00973002;
5.04	5635.774059	28037	28.29288703	76.9839196;
5.08	5610.460251	28324.5	28.77322176	77.16757169;
5.12	5714.016736	28428	28.85523013	76.98469633;
5.16	5737.029289	28554.5	28.96066946	76.98998405;

5.2	5755.439331	28669.5	29.08953975	77.0002284;
5.24	5750.83682	28761.5	29.20669456	77.05041914;
5.28	5711.715481	28738.5	29.30041841	77.12561838;
5.32	5440.167364	27186	29.27698745	77.04040507;
5.36	5428.661088	27128.5	29.07782427	77.04040507;
5.4	5387.238494	26921.5	27.39079498	77.04040507;
5.44	5380.334728	26887	27.26192469	77.04040507;
5.48	5355.020921	26760.5	27.12133891	77.04040507;
5.52	5327.405858	26622.5	26.88702929	77.04040507;
5.56	5582.845188	27899	26.78158996	77.04040507;
5.6	5557.531381	27772.5	26.66443515	77.04040507;
5.64	5543.723849	27703.5	26.54728033	77.04040507;
5.68	5509.205021	27531	26.46527197	77.04040507;
5.72	5488.493724	27427.5	28.22259414	77.04040507;
5.76	5465.481172	27312.5	28.04686192	77.04040507;
5.8	5122.594142	25702.5	27.94142259	77.09083976;
5.84	5104.1841	25599	27.82426778	77.08541618;
5.88	5055.857741	25507	27.69539749	77.1590203;
5.92	5028.242678	25265.5	27.63682008	77.10881936;
5.96	4979.916318	25127.5	27.42594142	77.16081261;
6	4954.60251	24886	25.11799163	77.1040733;
6.04	4933.891213	26392.5	24.97740586	77.86697598;
6.08	5281.380753	26289	24.83682008	76.99111532;
6.12	5260.669456	26174	24.77824268	76.98539932;
6.16	5237.656904	26059	24.6376569	76.98515663;
6.2	5214.644351	25978.5	24.54393305	77.00160875;
6.24	5198.535565	25863.5	24.41506276	76.98473911;
6.28	5175.523013	24092.5	26.34811715	76.12339642;
6.32	5143.305439	23966	26.18410042	76.13646444;
6.36	4676.150628	23816.5	26.07866109	77.27643662;
6.4	4630.125523	23483	25.98493724	77.22450835;
6.44	4602.51046	23368	25.73891213	77.23775871;
6.48	4614.016736	23138	25.59832636	77.08397857;
6.52	4643.933054	24759.5	25.35230126	77.82801398;
6.56	4830.334728	24656	25.22343096	77.30350447;
6.6	4936.192469	24518	25.12970711	76.96407438;
6.64	4975.313808	24380	25.32887029	76.79257462;
6.68	4906.276151	24322.5	25.48117155	76.93979556;
6.72	4878.661088	24184.5	25.7623431	76.9392217;
6.76	4867.154812	25012.5	25.37573222	77.38631749;
6.8	4839.539749	25288.5	25.80920502	77.58825783;
6.84	4821.129707	24909	25.96150628	77.45154106;
6.88	4795.8159	25334.5	24.26276151	77.71862435;
6.92	4765.899582	25484	23.92301255	77.86241395;
6.96	4699.16318	25633.5	23.80585774	78.09526617;
7	5129.497908	23000	23.57154812	75.61513039;

7.04	5166.317992	23057.5	23.43096234	75.55080822;
7.08	5216.945607	23207	23.48953975	75.50520883;
7.12	5272.175732	24138.5	23.641841	75.90037963;
7.16	5366.527197	24667.5	24.59079498	75.95363258;
7.2	5005.230126	24863	28.10543933	76.96513323;
7.24	5060.460251	27588.5	28.25774059	78.08862536;
7.28	4984.518828	27738	28.3748954	78.32390272;
7.32	5069.665272	27853	28.52719665	78.1776891;
7.36	5099.58159	28002.5	28.69121339	78.17159135;
7.4	5635.774059	28163.5	28.84351464	77.04040507;
7.44	5665.690377	28313	29.00753138	77.04040507;
7.48	5697.90795	25817.5	29.12468619	75.75878893;
7.52	5720.920502	26070.5	26.11380753	75.83675508;
7.56	5741.631799	26346.5	26.30125523	75.93049801;
7.6	5757.740586	26818	26.55899582	76.13097148;
7.64	5412.552301	27048	26.84016736	77.04040507;
7.68	5504.60251	27508	27.32050209	77.04040507;
7.72	5520.711297	29348	27.55481172	77.79336824;
7.76	5550.627615	29463	28.02343096	77.77567277;
7.8	5573.640167	29451.5	30.12050209	77.7218776;
7.84	5603.556485	29670	29.53472803	77.74612459;
7.88	5801.464435	29566.5	29.31213389	77.28416751;
7.92	5757.740586	28991.5	29.07782427	77.13481583;
7.96	5711.715481	28474	28.96066946	77.01006448;
8	5688.702929	28589	28.84351464	77.11094357;
8.04	5665.690377	28692.5	28.72635983	77.20613756;
8.08	5642.677824	28773	28.71464435	77.29089665;
8.12	5640.376569	28888	29.23012552	77.34485321;
8.16	5780.753138	29233	29.31213389	77.18827473;
8.2	5849.790795	28163.5	29.4292887	76.56580038;
8.24	5872.803347	28612	29.78075314	76.71871326;
8.28	5895.8159	28600.5	29.89790795	76.66335635;
8.32	5893.514644	28359	30.01506276	76.55894959;
8.36	5937.238494	28198	30.00334728	76.38846377;
8.4	5916.527197	28186.5	30.22594142	76.42885809;
8.44	5640.376569	28773	28.67949791	77.29591156;
8.48	5635.774059	28543	28.87866109	77.2070062;
8.52	5633.472803	28428	28.50376569	77.16203788;
8.56	5672.594142	28313	28.48033473	77.02514759;
8.6	5598.953975	28198	28.45690377	77.13747361;
8.64	5635.774059	28186.5	28.4334728	77.05062343;
8.68	5725.523013	27910.5	28.41004184	76.72607674;
8.72	5723.221757	27887.5	28.38661088	76.72066739;
8.76	5674.895397	27864.5	28.69121339	76.81838007;
8.8	5642.677824	27841.5	29.14811715	76.88016813;
8.84	5566.736402	27818.5	29.13640167	77.04040507;

8.88	5562.133891	27795.5	28.89037657	77.04040507;
8.92	5557.531381	28163.5	28.72635983	77.21437277;
8.96	5559.832636	28152	28.71464435	77.20419963;
9	5564.435146	28347.5	28.69121339	77.27939058;
9.04	5566.736402	27979.5	28.30460251	77.11248061;
9.08	5594.351464	27956.5	28.2460251	77.04040507;
9.12	5589.748954	27933.5	28.22259414	77.04040507;
9.16	5585.146444	27726.5	28.19916318	76.95733332;
9.2	5580.543933	27703.5	28.1874477	76.95726425;
9.24	5575.941423	27680.5	28.12887029	76.95719519;
9.28	5571.338912	27669	28.10543933	76.96236176;
9.32	5624.267782	27611.5	28.36317992	76.81634754;
9.36	5635.774059	27588.5	28.33974895	76.77969475;
9.4	5628.870293	27772.5	28.31631799	76.87977029;
9.44	5619.665272	27784	28.29288703	76.90572074;
9.48	5635.774059	27807	28.30460251	76.87996946;
9.52	5628.870293	27818.5	28.32803347	76.90071686;
9.56	5555.230126	27772.5	28.33974895	77.04559031;
9.6	5536.820084	27784	28.29288703	77.09224565;
9.64	5541.422594	28163.5	28.69121339	77.25021954;
9.68	5557.531381	28129	28.65606695	77.19920764;
9.72	5559.832636	27761	28.28117155	77.03003096;
9.76	5548.32636	27669	28.1874477	77.01438519;
9.8	5543.723849	27692	28.21087866	77.03520498;
9.84	5539.121339	27485	28	76.95136781;
9.88	5536.820084	28106	28.63263598	77.23525352;
9.92	5525.313808	28163.5	28.69121339	77.28607646;
9.96	5520.711297	28129	28.65606695	77.28124874;
10	5500	28083	28.60920502	77.30733445

];

%now, smooth the data for horizontal force, vertical force, and blade angle
for k=1:240

smoothfx(k)=(uinput(k,3)+uinput(k+1,2)+uinput(k+2,2)+uinput(k+3,2)+uinput(k+4,2)+uinput(k+5,2)+uinput(k+6,2)+uinput(k+7,2)+uinput(k+8,2)+uinput(k+9,2))/10.0;

smoothfy(k)=(uinput(k,3)+uinput(k+1,3)+uinput(k+2,3)+uinput(k+3,3)+uinput(k+4,3)+uinput(k+5,3)+uinput(k+6,3)+uinput(k+7,3)+uinput(k+8,3)+uinput(k+9,3))/10.0;

smoothba(k)=(uinput(k,3)+uinput(k+1,4)+uinput(k+2,4)+uinput(k+3,4)+uinput(k+4,4)+uinput(k+5,4)+uinput(k+6,4)+uinput(k+7,4)+uinput(k+8,4)+uinput(k+9,4))/1000.0;

end;

smoothfx=smoothfx';

smoothfy=smoothfy';

smoothba=smoothba';

%now determine the force angle from the smoothed horizontal and vertical

```

%force data
for k=1:240
    rat=smoothfy(k)/smoothfx(k);
    smoothfa(k)=(atan(rat))*(180/3.14159);
end;
smoothfa=smoothfa';
%now perform the various checks
for k=1:240
    baout(k)=0.0;
    fyout(k)=0.0;
    if smoothba(k)>30.0
        baout(k)=29.0;
    elseif smoothba(k)<0.0
        baout(k)=16.0;
    elseif smoothfx(k)<2000.0
        if smoothfy(k)<20000.0
            fyout(k)=25000.0;
        elseif smoothba(k)>22.5
            baout(k)=15.0;
        else
            baout(k)=28.0;
        end
    elseif smoothfa(k)>80.0
        if smoothfy(k)<20000.0
            fyout(k)=25000;
        elseif smoothba(k)>22.5
            baout(k)=15.0;
        else
            baout(k)=28.0;
        end
    elseif smoothfy(k)>29000.0
        fyout(k)=26000.0;
    elseif smoothfy(k)<20000.0
        fyout(k)=24000.0;
    end
end;
%now report on the values of baout and fyout as set by the program
%different values indicate different violations of the rules
baout=baout';
fyout=fyout';

```